



VICTORY II™ Cast-iron power vent gas boilers

BOILER REPLACEMENT PARTS LIST

This parts list must be left with owner, hung on or adjacent to the boiler. Owner should retain parts list for future reference.

VHS Models with Intermittent Pilot System - Spark Ignition

ITEM NO.	DESCRIPTION	MODEL NUMBERS					
		VHS-30	VHS-60	VHS-90	VHS-120	VHS-150	VHS-180
1	Jacket Top Panel	440051	440052	440053	440054	440055	440056
2	Jacket Back Panel	412182	412183	412184	412185	412186	412187
3	Jacket Left Panel	440067	440067	440067	440067	440067	440067
4	Jacket Right Panel	440733	440733	440733	440733	440733	440733
5	Jacket Front Upper Panel	440060	440061	440062	440063	440064	440065
6	Jacket Front Lower Panel	460122	460123	460124	460125	460126	460127
7	Burner Mounting Plate	440111	440112	440113	440114	440115	440116
8	Base Assembly with Insulation	440013	440014	440015	440016	440017	440018
9	Heat Exchanger Assembly	440006	440007	440008	440009	440010	440011
10	Flue Collector Assembly	440712	440713	440714	440715	440716	440717
11	Access Door	440027	440028	440029	440030	440031	440032
12	Upper Control Box Bracket	440771	440771	440771	440771	440771	440771
13	Lower Control Box Bracket	440732	440732	440732	440732	440732	440732
14	Burner	440539	440539	440539	440539	440539	440539
15	Burner with Bracket	440540	440540	440540	440540	440540	440540
16	Main Burner Orifice, Natural Gas	440552	440552	440552	440552	440552	440552
16	Main Burner Orifice, Propane Gas	440553	440553	440553	440553	440553	440553
17	Burner Clip	410509	410509	410509	410509	410509	410509
18	Gas Manifold	440501	440502	440503	440504	440505	440506
19	Pilot Burner Assembly w/cable, Natural Gas	412075	412075	412075	412075	412075	412075
19	Pilot Burner Assembly w/cable, Propane	412067	412067	412067	412067	412067	412067
20	Gas Valve, Natural Gas	440534	440534	440534	440534	440534	440534
20	Gas Valve, Propane Gas	440535	440535	440535	440535	440535	440535
21	Pilot Tube, 1/4 O.D. Alum.	410530	410530	410530	410530	410530	410530
22	Junction Box	650607	650607	650607	650607	650607	650607
23	Junction Box Cover	650608	650608	650608	650608	650608	650608
24	Hydrolevel Hydrostat Control Model #3200	461010	461010	461010	461010	461010	461010
25	Ignition Control, Natural Gas	412101	412101	412101	412101	412101	412101
25	Ignition Control, L.P. Propane Gas	412102	412102	412102	412102	412102	412102
27	Well for Hydrolevel Control w/LWCO	461012	461012	461012	461012	461012	461012
28	Air Flow Pressure Switch	440856	440856	440856	440856	440856	440856
29	Pressure Switch Plastic Tubing	440760	440760	440760	440760	440760	440760
30	Inducer Relay	440543	440543	440543	440543	440543	440543
31	Circulator	7902022	7902022	7902022	7902022	7902022	7902022
32	Inducer Inlet Assembly	440762	440763	440764	440765	440766	440767
33	Blower Assembly (Inducer)	440745	440745	440745	440745	440745	440745
34	Flue Collar, Adapter and Cond. Drain	455026	455026	455026	455026	455026	455026
35	Condensation Drain Plastic Tubing	440802	440802	440802	440802	440802	440802
36	90° Turn Stud	650541	650541	650541	650541	650541	650541
37	Control Box	440768	440768	440768	440768	440768	440768
38	Pipe Nipple, 3/4"	400225	400225	400225	400225	400225	400225
39	Relief Valve, 30 psi	400103	400103	400103	400103	400103	400103
40	Drain Valve	910460011	910460011	910460011	910460011	910460011	910460011
41	Temperature/Pressure Gauge	910373061	910373061	910373061	910373061	910373061	910373061
42	Roll-out Safety Switch	411883	411883	440720	440720	440721	460547
-	Pilot Orifice, Natural Gas (Not Shown)	410542	410542	410542	410542	410542	410542
-	Pilot Orifice, Propane (Not Shown)	410524	410524	410524	410524	410524	410524

When ordering replacement parts, specify the boiler model number, serial number and gas by name (natural or propane). For replacement parts, heating contractors should contact their Slant/Fin boiler distributor.

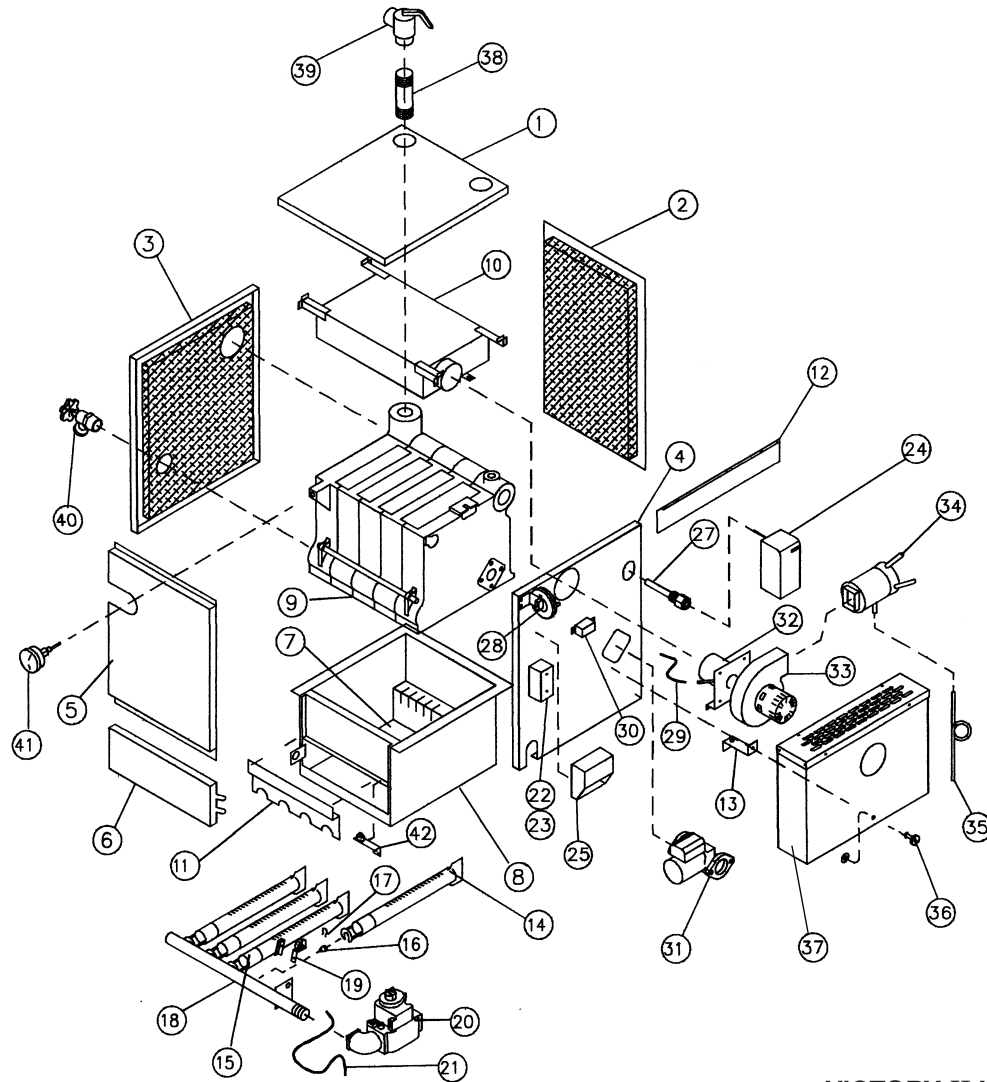

VICTORY II VHS MODELS

OPTIONAL VENT SYSTEM PARTS

3" diameter Heat-Fab Saf-T venting system (AL29-4C[†] stainless steel)

DESCRIPTION	Slant/Fin Part No.	Heat-Fab Part No.
6" long vent pipe	440671	7301GC
12" long vent pipe	440672	7302GC
18" long vent pipe	440673	7304GC
24" long vent pipe	440674	7305GC
36" long vent pipe	440675	7307GC
48" long vent pipe	440676	7308GC
Elbow termination with screen	440678	7314TERM
Support, 6" clearance	440679	7323GCC
Support, 2" clearance	440692	7323GC2
Support clamp	440680	4327SS
45° elbow	440681	7311GC
90° elbow	440682	7314GC
TEE termination with screen	440683	7390TEE

DESCRIPTION	Slant/Fin Part No.	Heat-Fab Part No.
Fire stop	440685	5318CI
Tight radius 90° elbow	440668	7314GCTR
3" x 5" vent adapter	660549	73FINADP
Sealant GE-RTV 106 -3 oz. Tube	440690	—
Sealant Dow Corning 732 -3 oz. Tube	440691	—
Sealant Dow Corning 732 -10 oz. Cartridge	440693	—

†: AL 29-4C is registered trademark of Allegheny Ludlum Corp.

* Must be used with slip joint connector.



SLANT/FIN CORPORATION, Greenvale, N.Y. 11548 • Phone: (516) 484-2600

FAX: (516) 484-0933 • Canada: Slant/Fin LTD/LTEE, Mississauga, Ontario

www.slantfin.com